

Model TDC2060N10H

Features

Low VSWR
High Directivity
Broadband & Miniature Size

Technical Data Sheet			
Frequency Range	2~6GHz	Finish	Painted Blue_ RAL #5007
Insertion Loss	≤0.5dB (Excl. Coupling Loss 0.46dB)	Connector Body	Brass, Tri-Alloy Platel
Coupling Factor	≤10±1.0dB	Housing	Aluminum, 6061 T6 Clear Chem Conversion Film
Coupling Sensitivity	≤±0.7dB	Connector Pin	Beryllium Copper, Gold Plate
Directivity	≥15dB	Solder	Lead Free, RoHS Compliant
VSWR	Primary ≤1.30:1 Secondary ≤1.30:1	Operating Temperature	-55~+85°C
¹ Power Handling	Incident ≤150Watt; Reflected ≤2Watt	Operating Humidity	Up to 95%, Non- Condensing
Impedance	50Ω	Weight	160g
Port Connectors	N-Female		

¹Power Handling guaranteed when load's VSWR within 1.50:1.

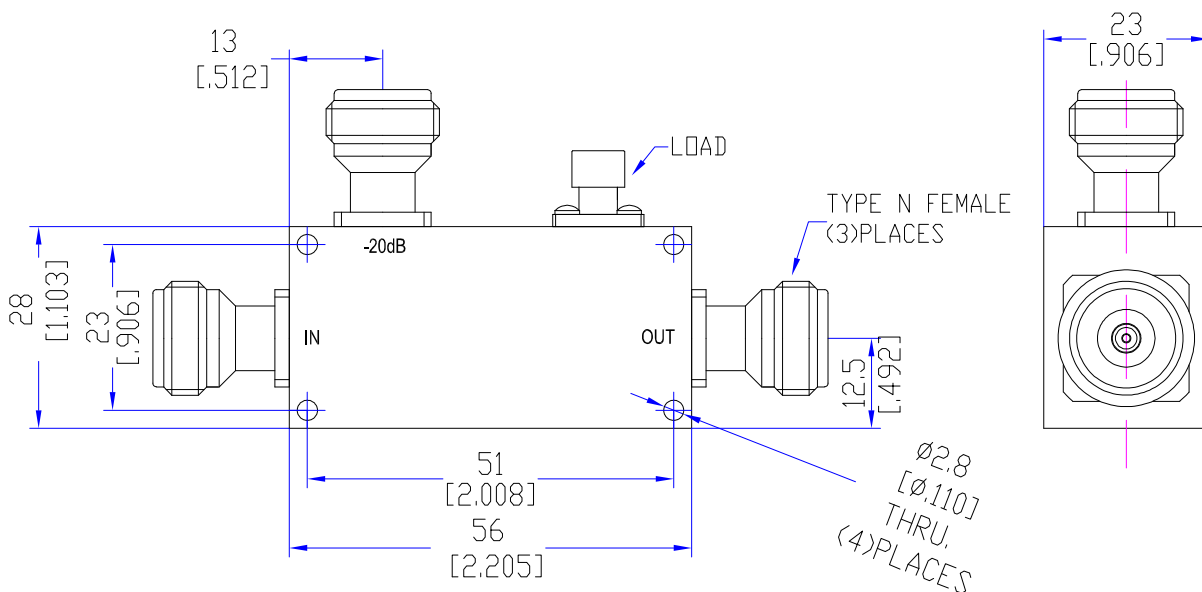

Typical Performance

1. Coupling Factor & Sensitivity, Isolation, VSWR

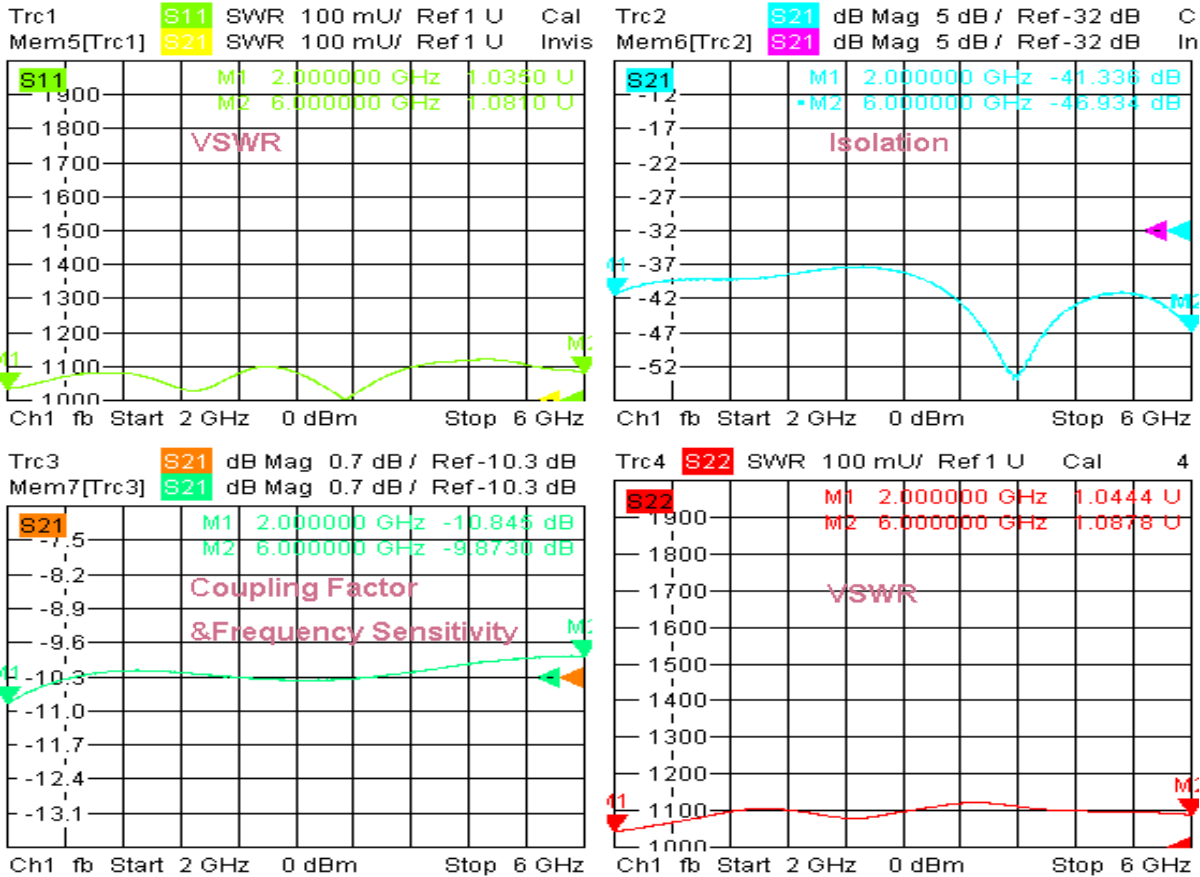

8/4/2020, 1:20 PM

2. Insertion Loss

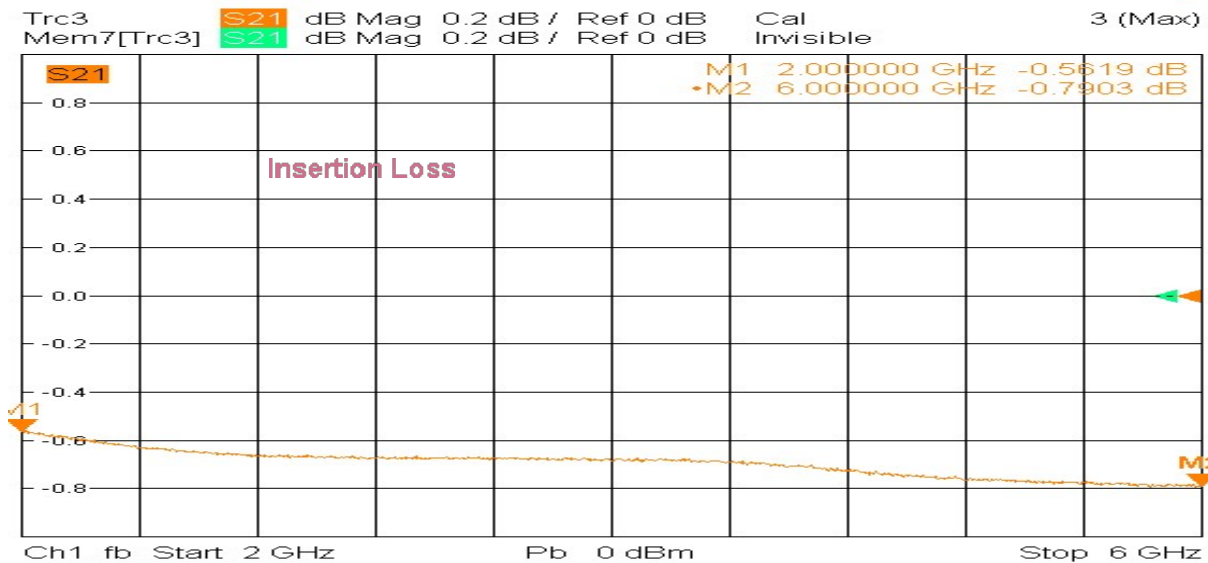

8/4/2020, 1:19 PM

