

Model TDC3040N20

Features

Low VSWR
High Directivity
Broadband & Miniature Size

Technical Data Sheet			
Frequency Range	3~4GHz	Finish	Painted Blue_ RAL #5007
Insertion Loss	≤0.4dB (Excl. Coupling Loss 0.04dB)	Connector Body	Brass, Tri-Alloy Platel
Coupling Factor	≤20±1.0dB	Housing	Aluminum, 6061 T6 Clear Chem Conversion Film
Coupling Sensitivity	≤±0.7dB	Connector Pin	Beryllium Copper, Gold Plate
Directivity	≥20dB	Solder	Lead Free, RoHS Compliant
VSWR	Primary ≤1.20:1 Secondary ≤1.20:1	Operating Temperature	-55~+85°C
¹ Power Handling	Incident ≤50Watt; Reflected ≤2Watt	Operating Humidity	Up to 95%, Non- Condensing
Impedance	50Ω	Weight	160g
Port Connectors	N-Female		

¹Power Handling guaranteed when load's VSWR within 1.50:1.

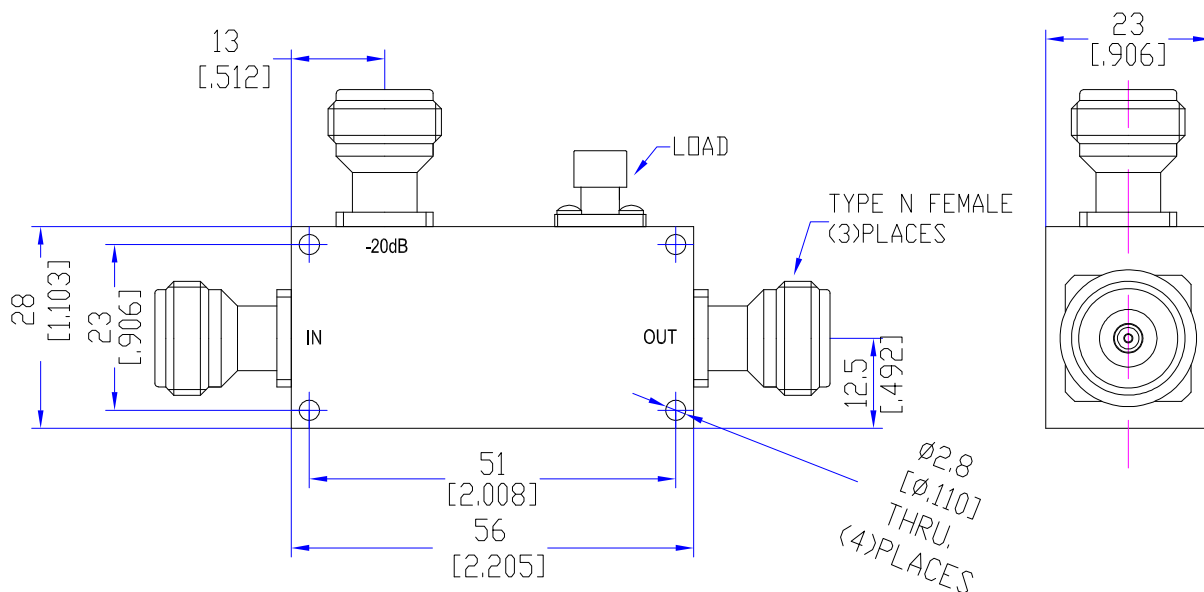

Typical Performance

1. Coupling Factor & Sensitivity, Isolation, VSWR

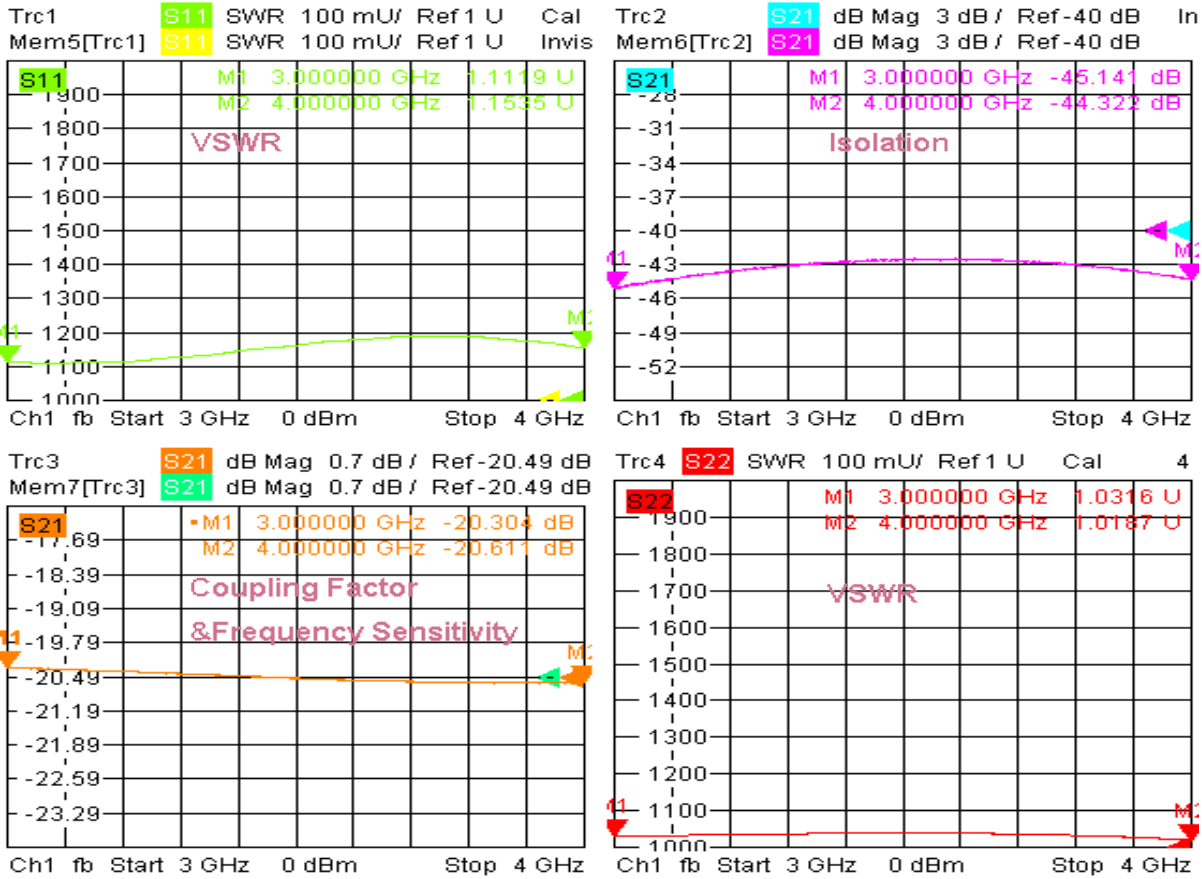

2/22/2019, 5:04 PM

2. Insertion Loss

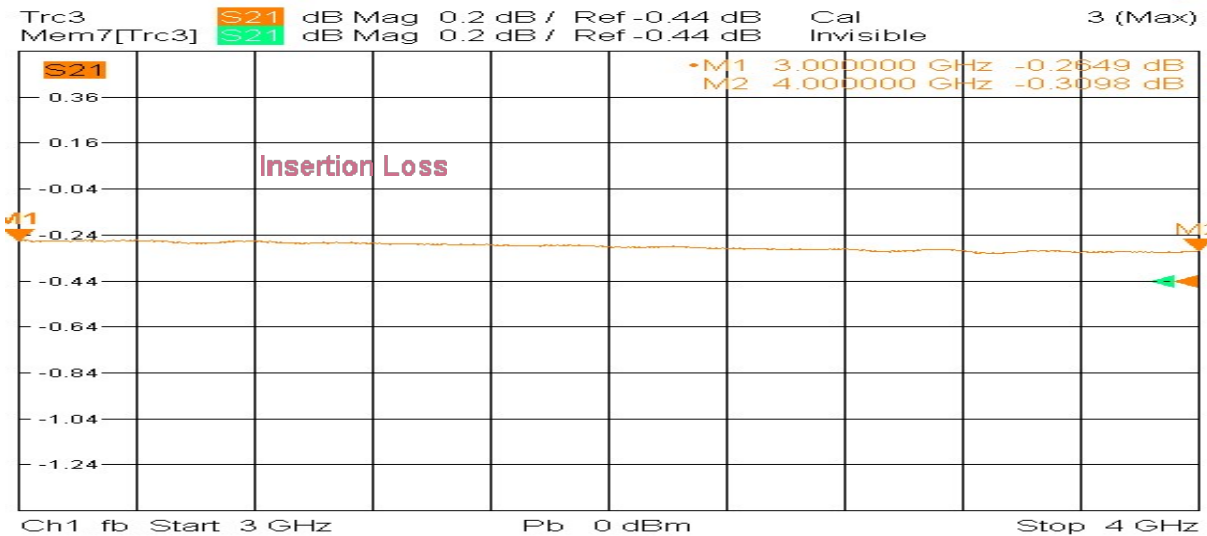

2/22/2019, 5:05 PM

