

Model TDC70124N30

Features

Low VSWR
High Directivity
Broadband & Miniature Size

Technical Data Sheet			
Frequency Range	7~12.4GHz	Finish	Painted Blue_ RAL #5007
Insertion Loss	≤0.8dB (Excl. Coupling Loss 0.01dB)	Connector Body	Brass, Tri-Alloy Platel
Coupling Factor	≤30±1.0dB	Housing	Aluminum, 6061 T6 Clear Chem Conversion Film
Coupling Sensitivity	≤±0.7dB	Connector Pin	Beryllium Copper, Gold Plate
Directivity	≥15dB	Solder	Lead Free, RoHS Compliant
VSWR	Primary ≤1.40:1 Secondary ≤1.40:1	Operating Temperature	-55~+85°C
¹ Power Handling	Incident ≤50Watt; Reflected ≤2Watt	Operating Humidity	Up to 95%, Non- Condensing
Impedance	50Ω	Weight	160g
Port Connectors	N-Female		

¹Power Handling guaranteed when load's VSWR within 1.50:1.

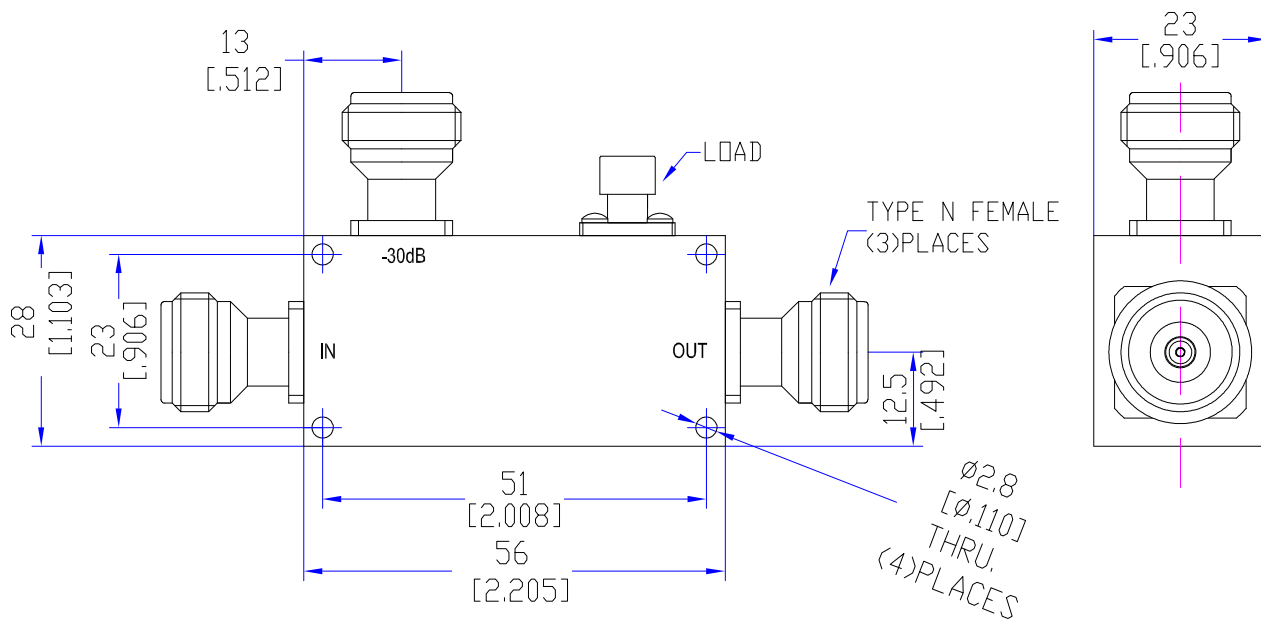

Typical Performance

1. Coupling Factor & Sensitivity, Isolation, VSWR

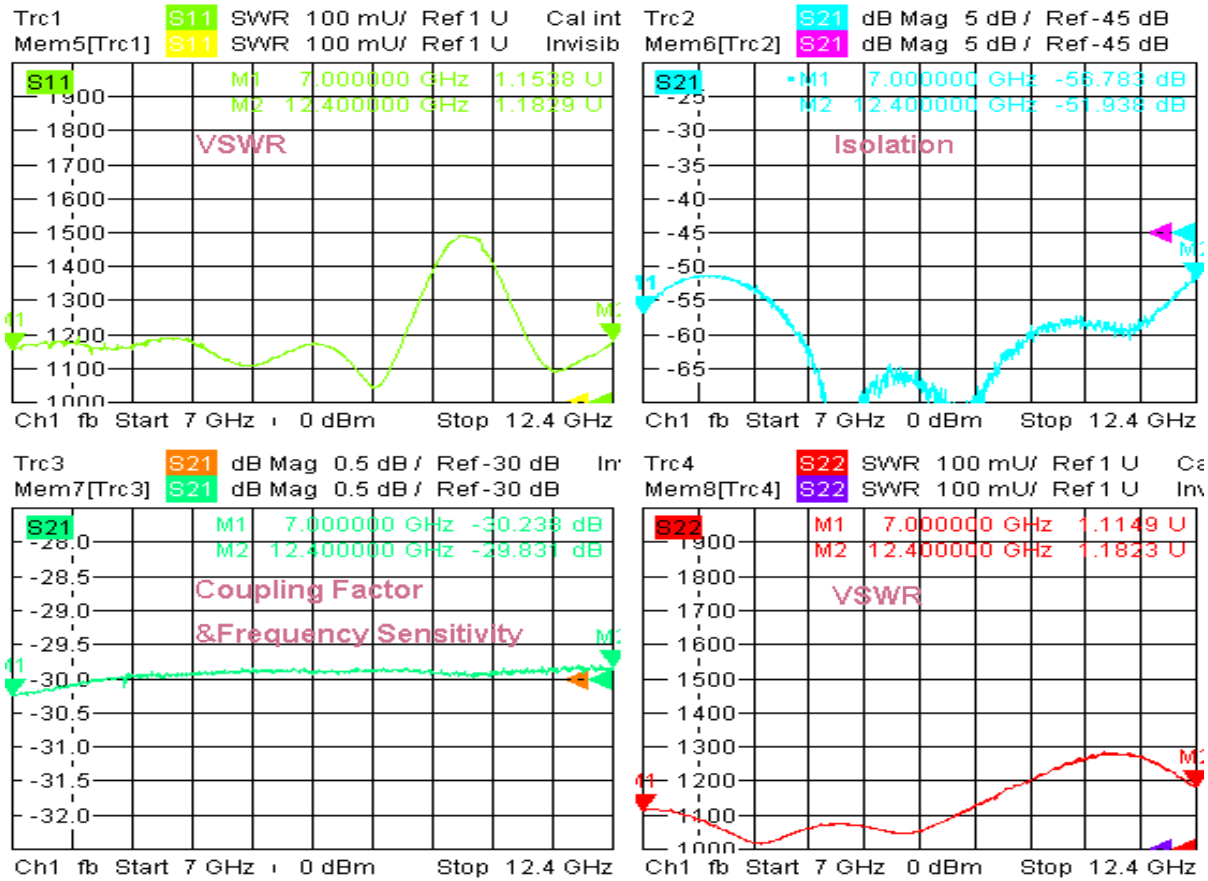

8/28/2018, 5:13 PM

2. Insertion Loss

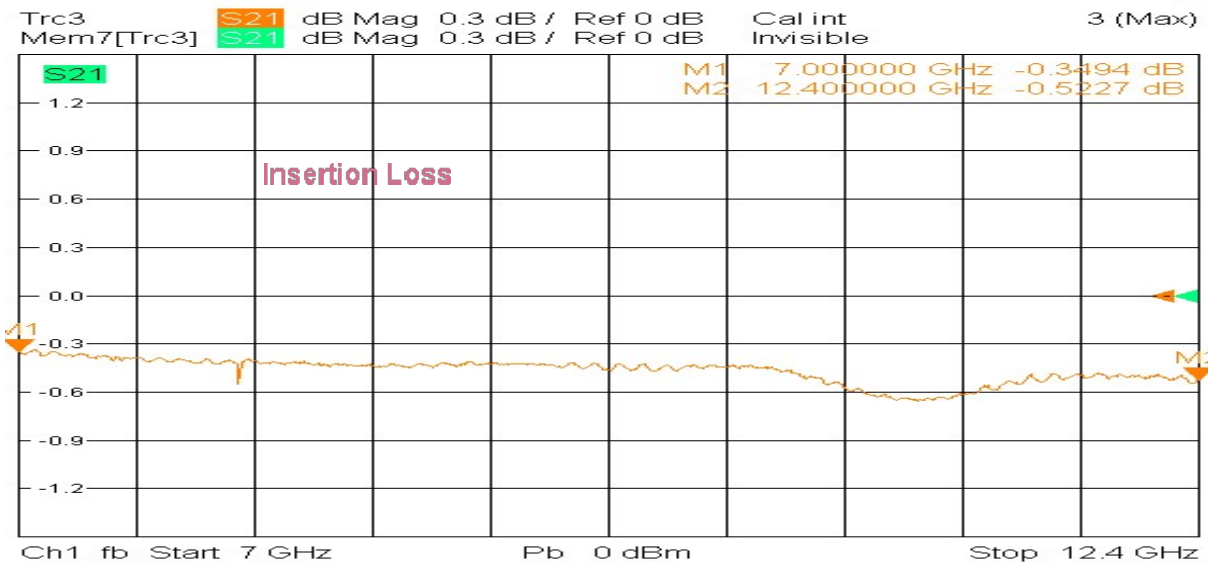

8/28/2018, 5:14 PM

