

Model THC1015B

Features

Excellent phase & amplitude balance
Low Insertion Loss & VSWR
High Isolation

| Technical Data Sheet | | | |
|-----------------------------|------------------------------|-----------------------|------------------------------|
| Frequency Range | 1.0~1.5GHz | Finish | Painted Blue_ RAL #5007 |
| Nominal Split | 3.01dB | Connector Body | Passivated Stainless Steel |
| Insertion Loss | ≤0.35dB | Housing | Aluminum, 6061 T6 |
| Isolation | ≥20dB | | Clear Chem Conversion Film |
| Amplitude Balance | ≤±0.3dB | Connector Pin | Beryllium Copper, Gold Plate |
| Phase Balance | ≤±3° | Solder | Lead Free, RoHS Compliant |
| VSWR | ≤1.25:1 | Operating Temperature | -55~+85°C |
| ¹ Power Handling | Average ≤20Watt Peak ≤1KW | Operating Humidity | Up to 95%, Non-Condensing |
| Impedance | 50Ω | Weight | 65g |
| Port Connectors | SMA-Female | | |

¹Power Handling guaranteed when load's VSWR within 1.50:1.

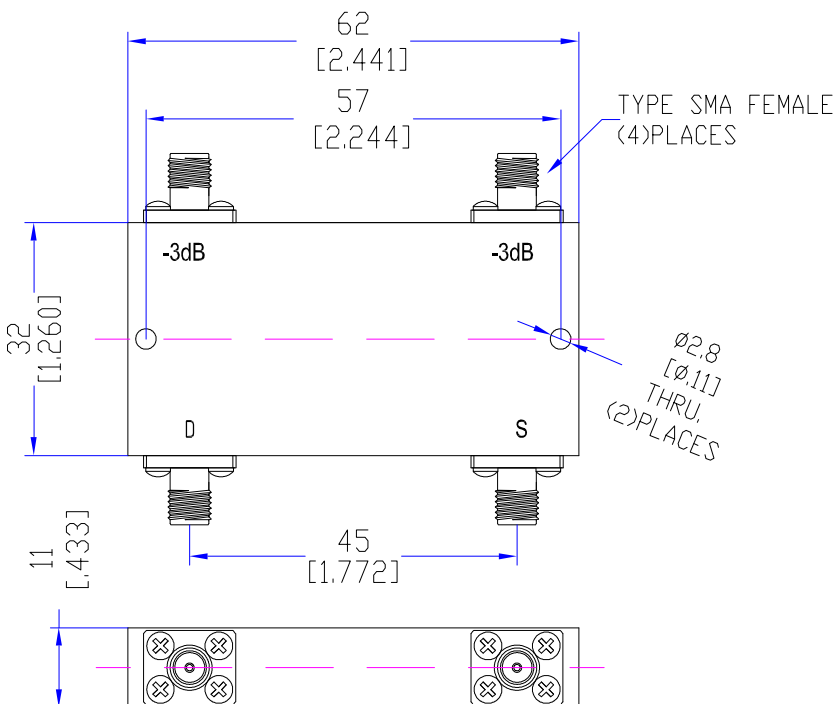

Typical Performance

1. Insertion Loss, Amplitude & Phase Balance, VSWR_0°

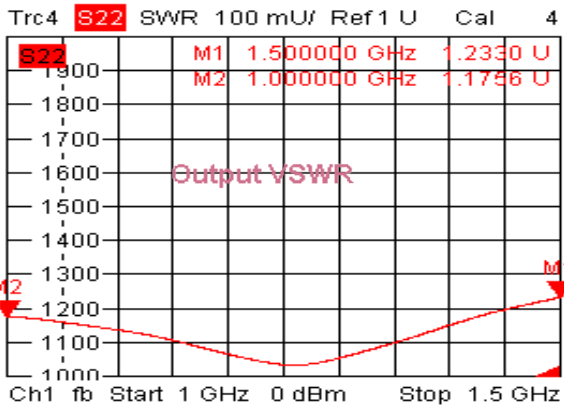
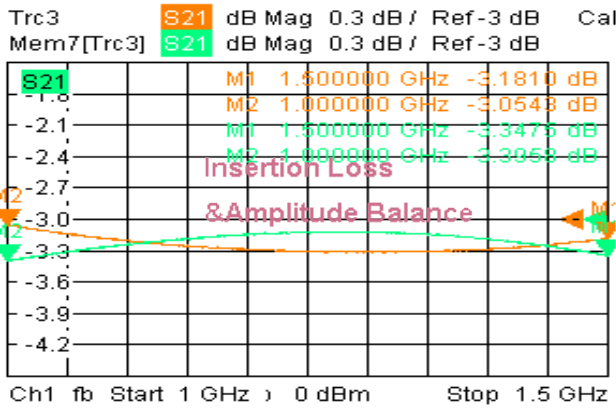
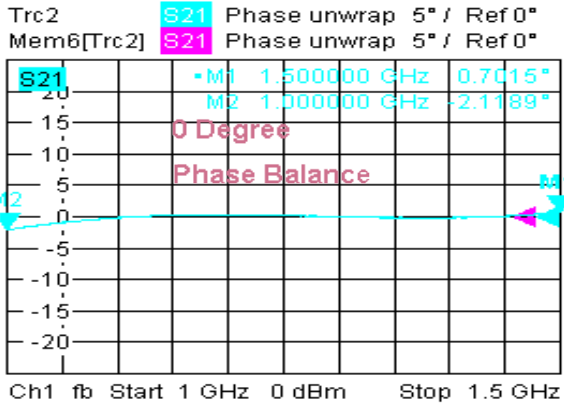
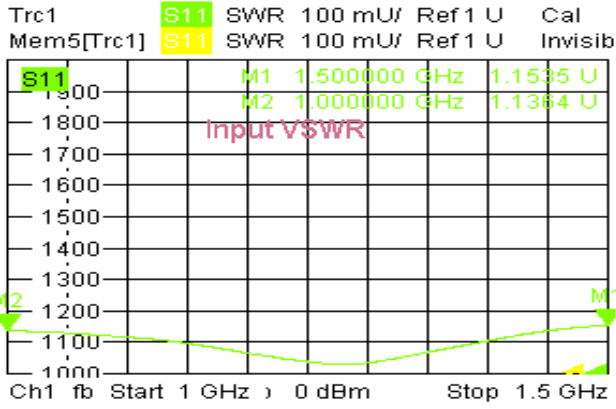

12/14/2018, 2:08 PM



Typical Performance

2. Insertion Loss, Amplitude & Phase Balance, VSWR _ 180°

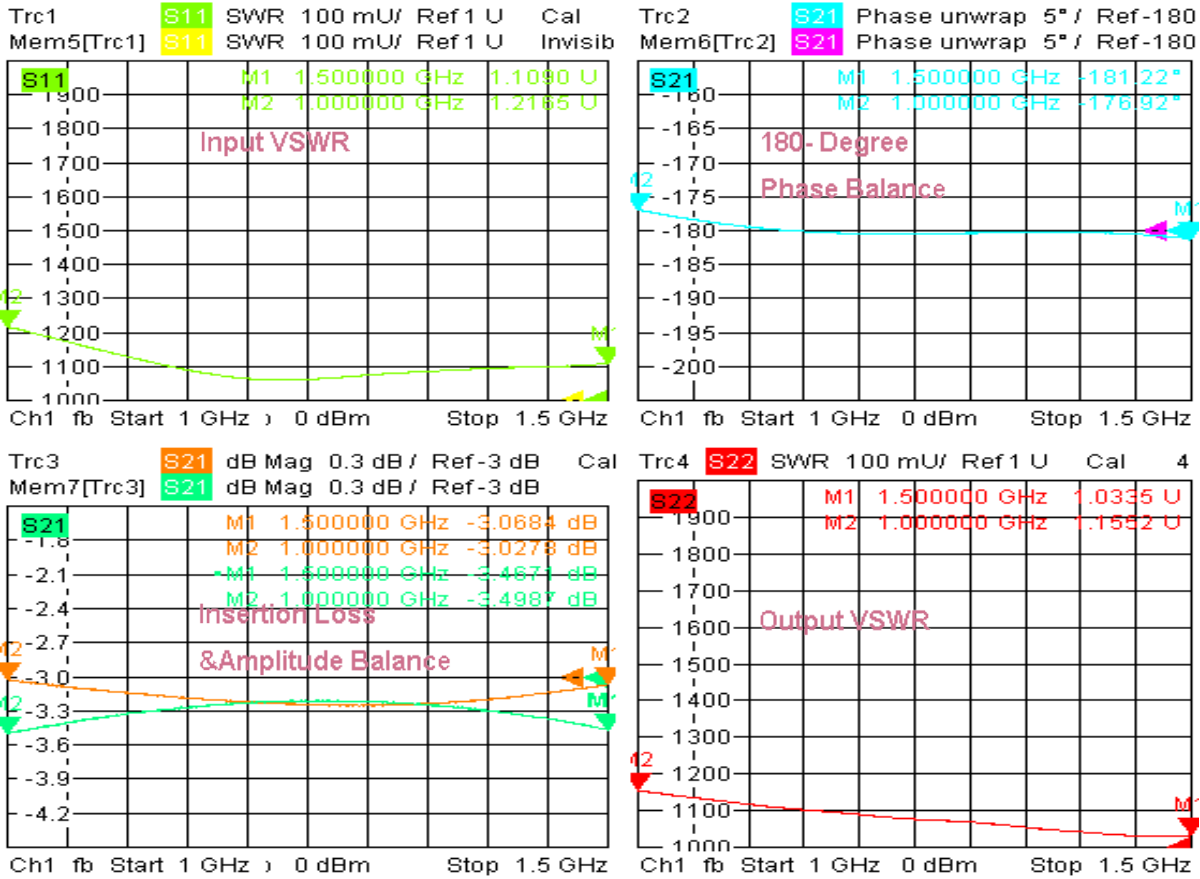

12/14/2018, 2:07 PM

3. Isolation

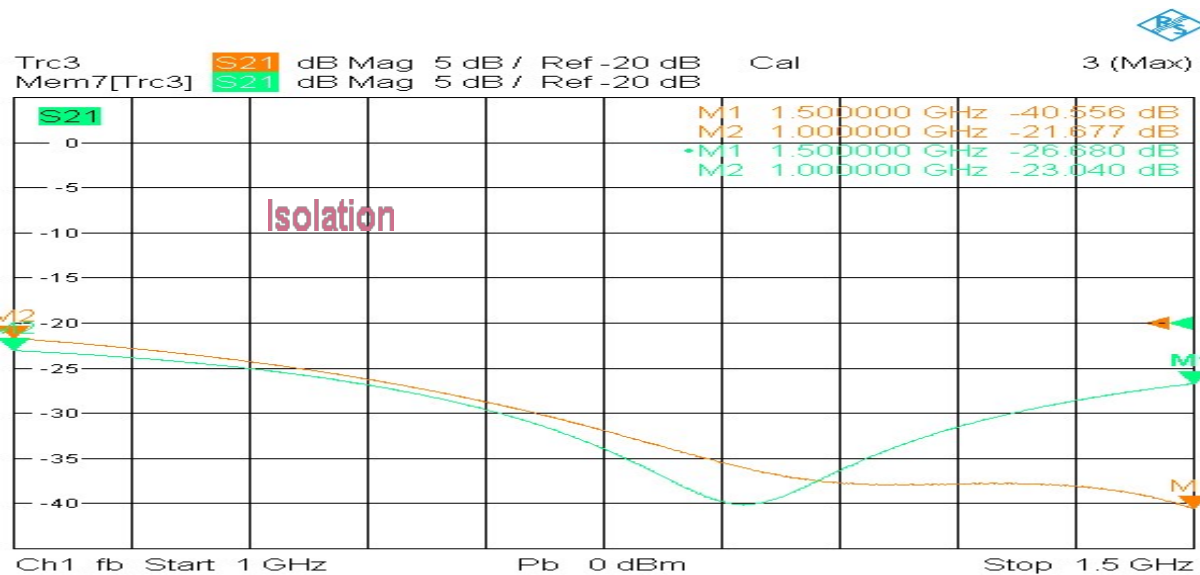

12/14/2018, 2:09 PM

