

Model THC2023B

Features

- Excellent phase & amplitude balance
- Low Insertion Loss & VSWR
- High Isolation

Technical Data Sheet			
Frequency Range	2.0~2.3GHz	Finish	Painted Blue_ RAL #5007
Nominal Split	3.01dB	Connector Body	Passivated Stainless Steel
Insertion Loss	≤0.5dB	Housing	Aluminum, 6061 T6
Isolation	≥18dB		Clear Chem Conversion Film
Amplitude Balance	≤±0.5dB	Connector Pin	Beryllium Copper, Gold Plate
Phase Balance	≤±5°	Solder	Lead Free, RoHS Compliant
VSWR	≤1.30:1	Operating Temperature	-55~+85°C
¹ Power Handling	Average ≤30Watt Peak ≤1KW	Operating Humidity	Up to 95%, Non-Condensing
Impedance	50Ω	Weight	30g
Port Connectors	SMA-Female		

¹Power Handling guaranteed when load's VSWR within 1.50:1.

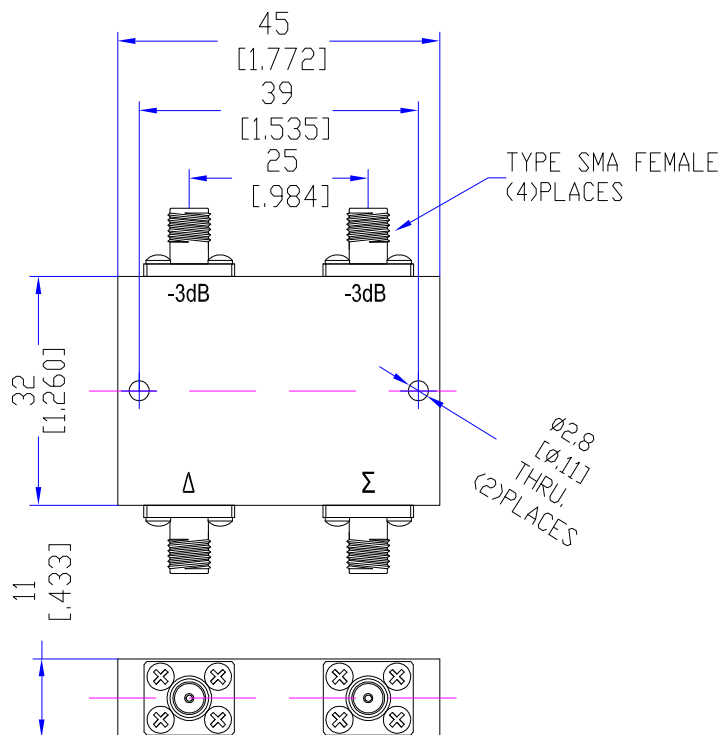

Typical Performance

1. Insertion Loss, Amplitude & Phase Balance, VSWR_{in} 0°



Trc1 Mem5[Trc1] S11 SWR 100 mU/ Ref 1 U Cal Invis

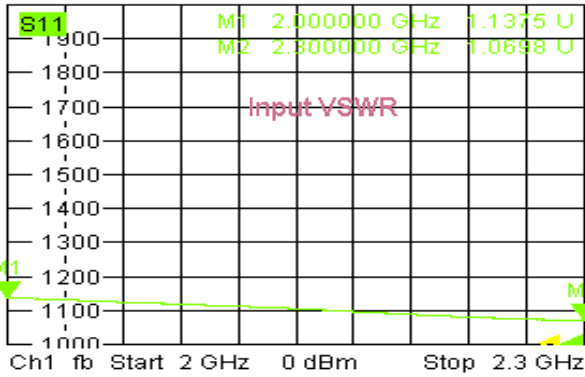

Trc2 Mem6[Trc2] S21 Phase unwrap 5° / Ref 0° C

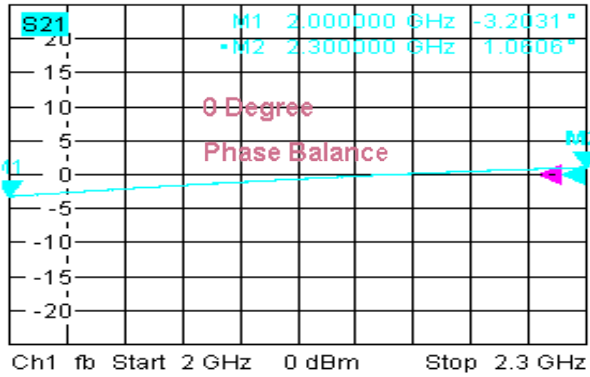

Trc3 Mem7[Trc3] S21 dB Mag 0.5 dB / Ref -3 dB C

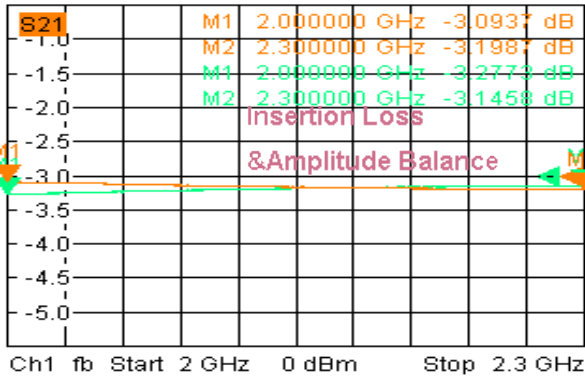

Trc4 S22 SWR 100 mU/ Ref 1 U Cal 4

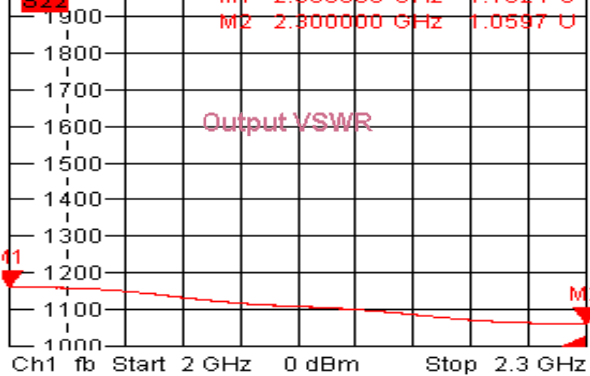

10/10/2019, 10:31 PM



Typical Performance

2. Insertion Loss, Amplitude & Phase Balance, VSWR _ 180°

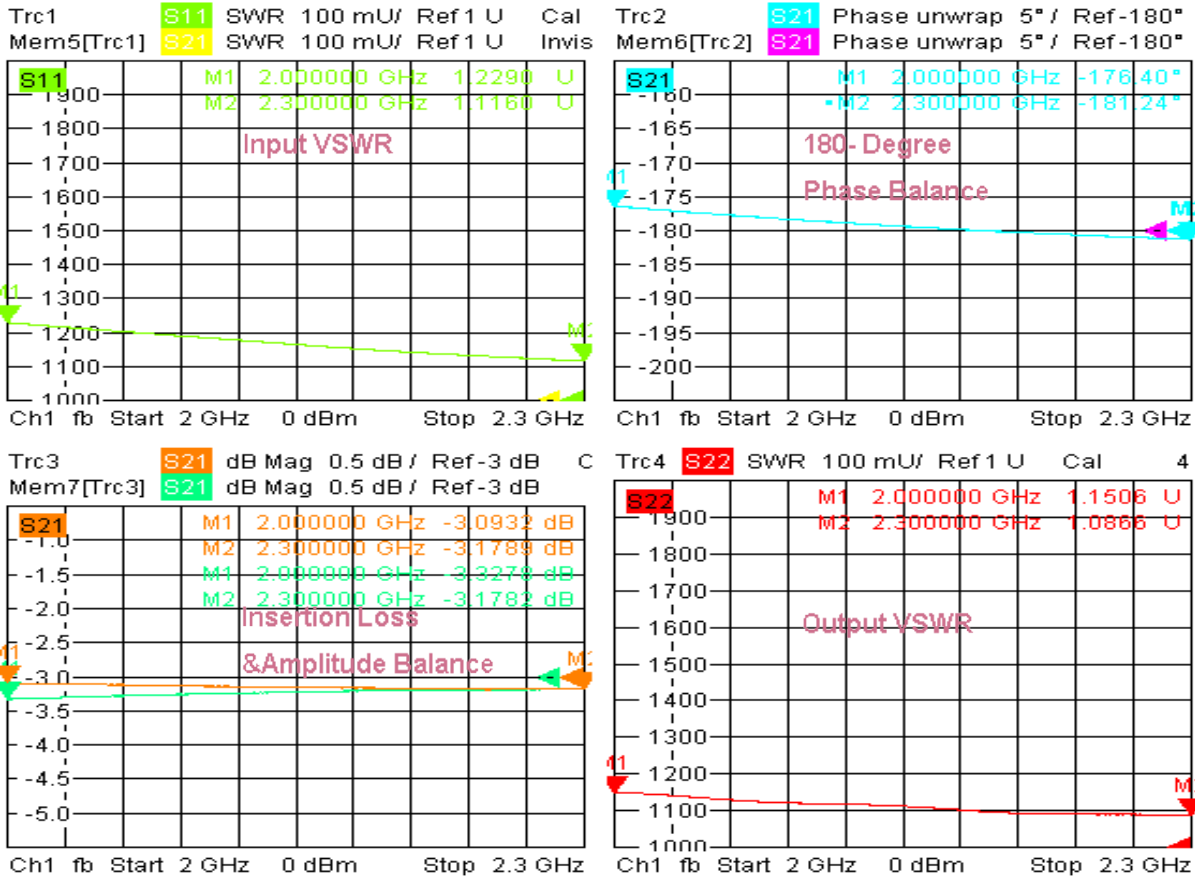

10/10/2019, 10:30 PM

3. Isolation

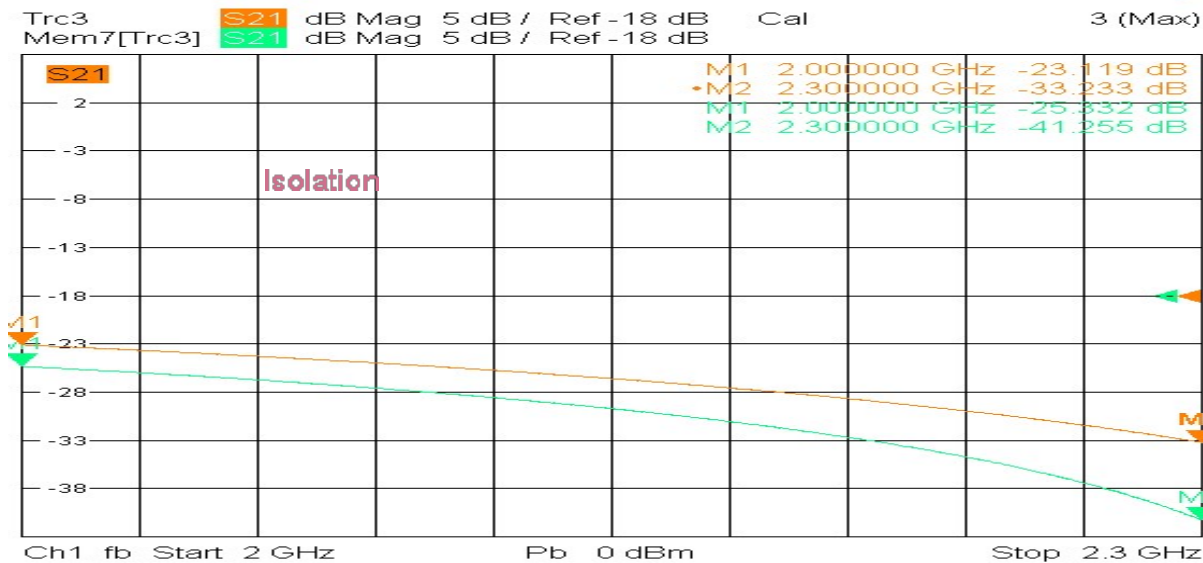

10/10/2019, 10:32 PM

