

## Model TDC10120N20DH

### Features

Low VSWR  
High Directivity  
Broadband & Miniature Size

Technical Data Sheet			
Frequency Range	1~12GHz	Finish	Painted Blue_ RAL #5007
Insertion Loss	≤0.9dB (Excl. Coupling Loss 0.08dB)	Connector Body	Passivated Stainless Steel
Coupling Factor	≤20±1dB	Housing	Aluminum, 6061 T6 Clear Chem Conversion Film
Coupling Sensitivity	≤±1dB	Connector Pin	Beryllium Copper, Gold Plate
Directivity	≥12dB	Solder	Lead Free, RoHS Compliant
VSWR	Primary ≤1.40:1 Secondary ≤1.40:1	Operating Temperature	-55~+85°C
<sup>1</sup> Power Handling	Incident ≤100Watt; Reflected ≤100Watt	Operating Humidity	Up to 95%, Non- Condensing
Impedance	50Ω	Weight	350
Port Connectors	N-Female		

<sup>1</sup>Power Handling guaranteed when load's VSWR within 1.50:1.

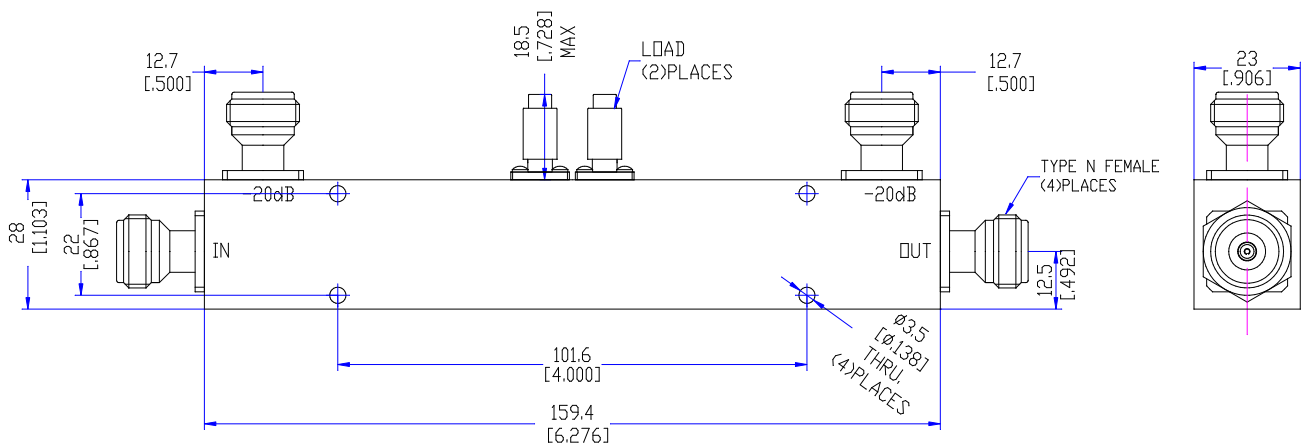

## Typical Performance

### 1. Coupling Factor & Sensitivity, Isolation, VSWR

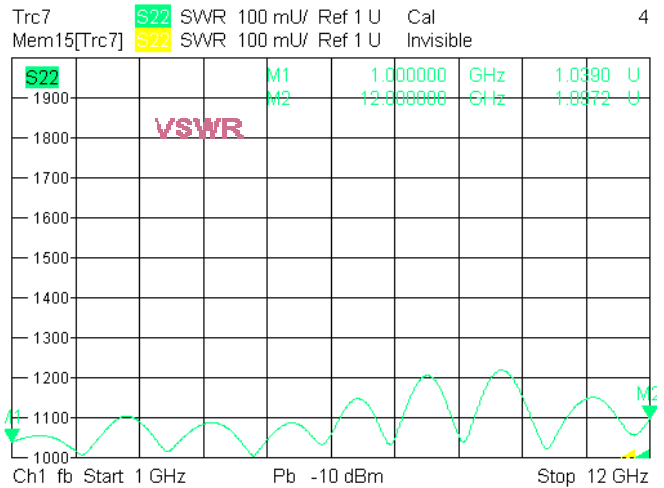
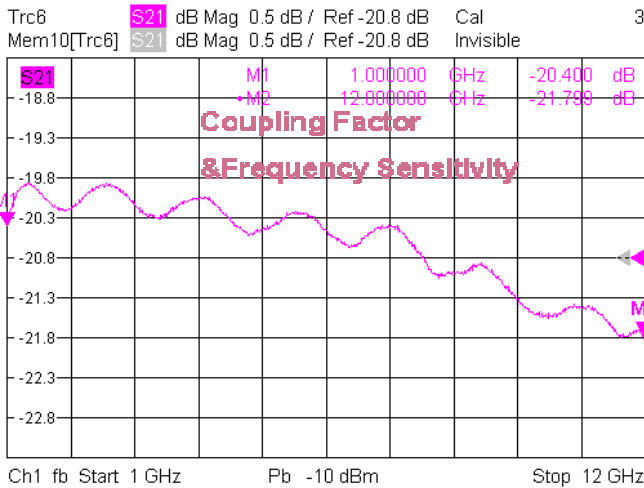
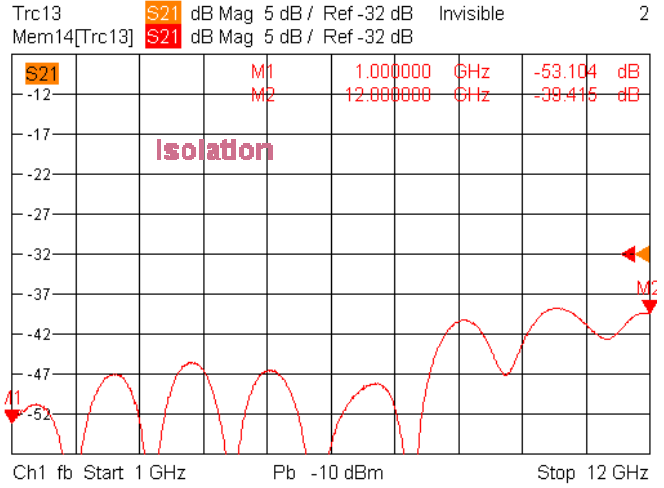
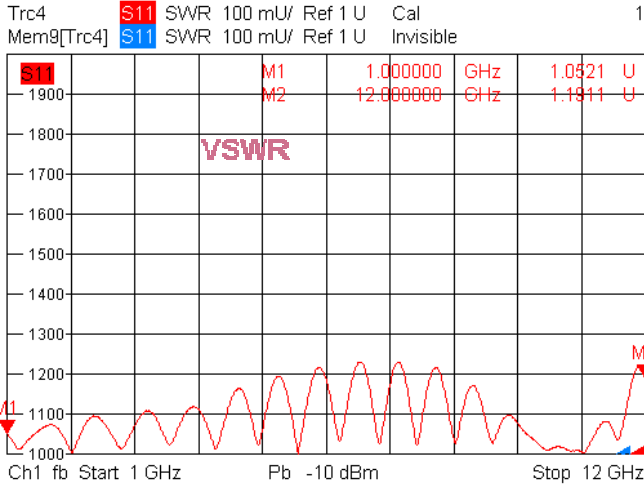

2/8/2023, 11:02 AM



## Typical Performance

### 2. Coupling Factor & Sensitivity, Isolation, VSWR

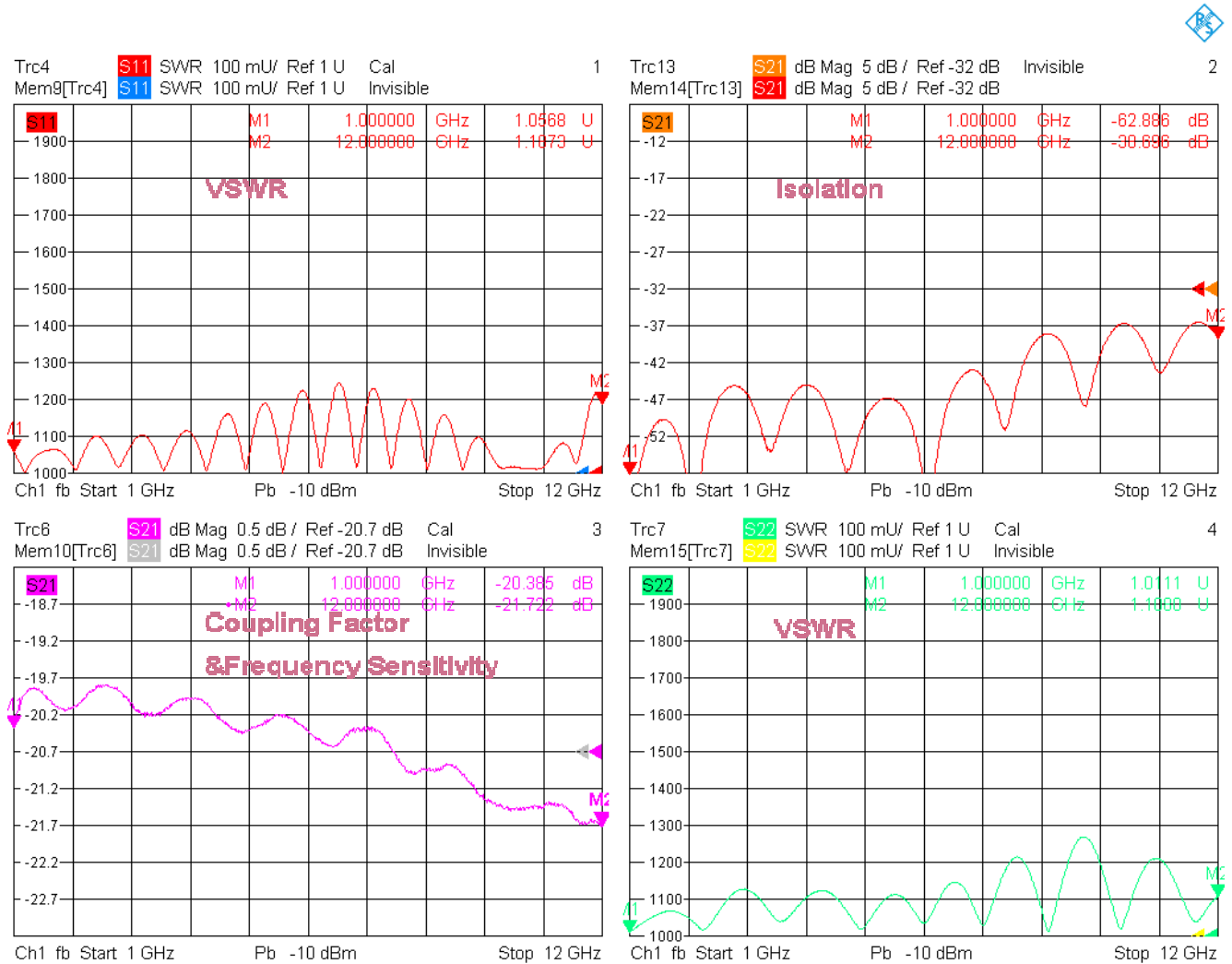

2/8/2023, 10:59 AM

### 3. Insertion Loss

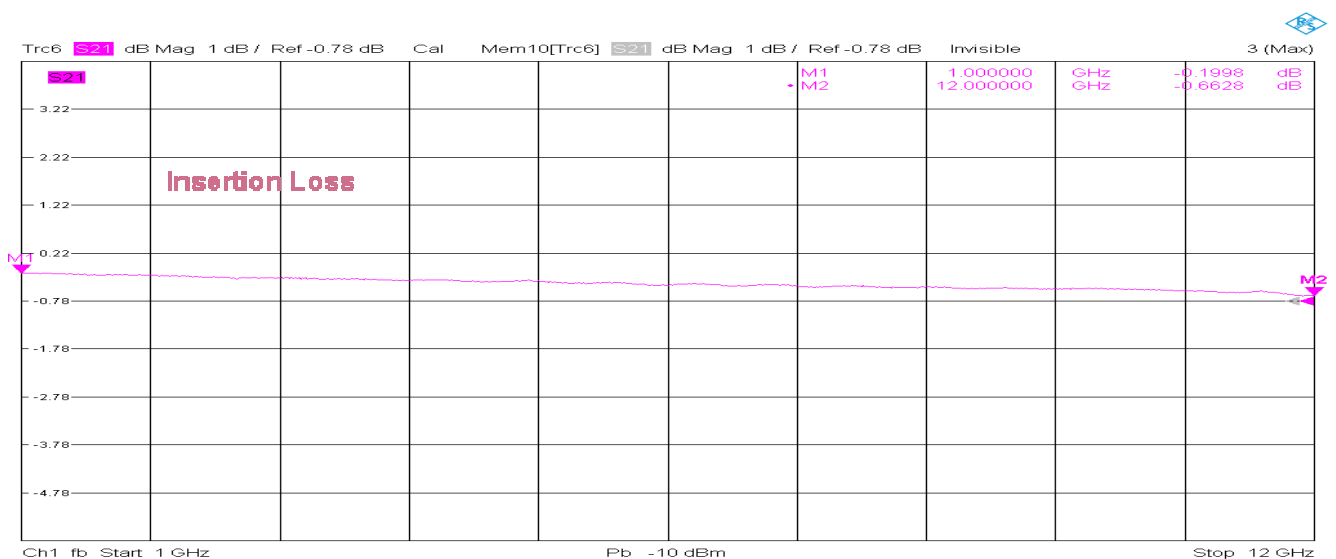

2/8/2023, 11:03 AM

