

Model TPD150400A2

Features

Excellent phase& amplitude balance
Low Insertion Loss& VSWR
High Isolation

Technical Data Sheet			
Frequency Range	15~40GHz	Finish	Painted Blue_ RAL #5007
Insertion Loss	≤1.20dB (Above 3.01dB Split)	Connector Body	Passivated Stainless Steel
VSWR	Input ≤1.60:1 Output ≤1.60:1	Housing	Aluminum, 6061 T6 Clear Chem Conversion Film
Isolation	≥16dB	Connector Pin	Beryllium Copper, Gold Plate
Amplitude Balance	≤±0.4dB	Solder	Lead Free, RoHS Compliant
Phase Balance	≤±4°	Operating Temperature	-55~+85°C
¹ Power Handling	Forward ≤20Watt; Reversed ≤1Watt	Operating Humidity	Up to 95%, Non- Condensing
Impedance	50Ω	Weight	25g
Port Connectors	2.92mm-Female		

¹Power Handling guaranteed when load's VSWR within 1.50:1.

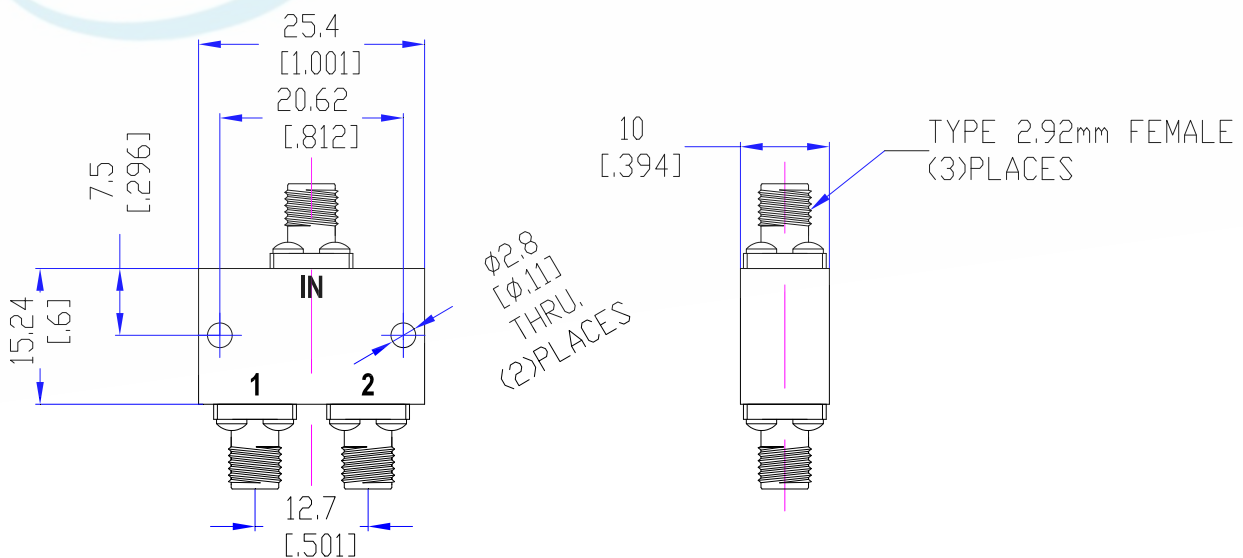

Typical Performance

1. Insertion Loss, Amplitude & Phase Balance, VSWR

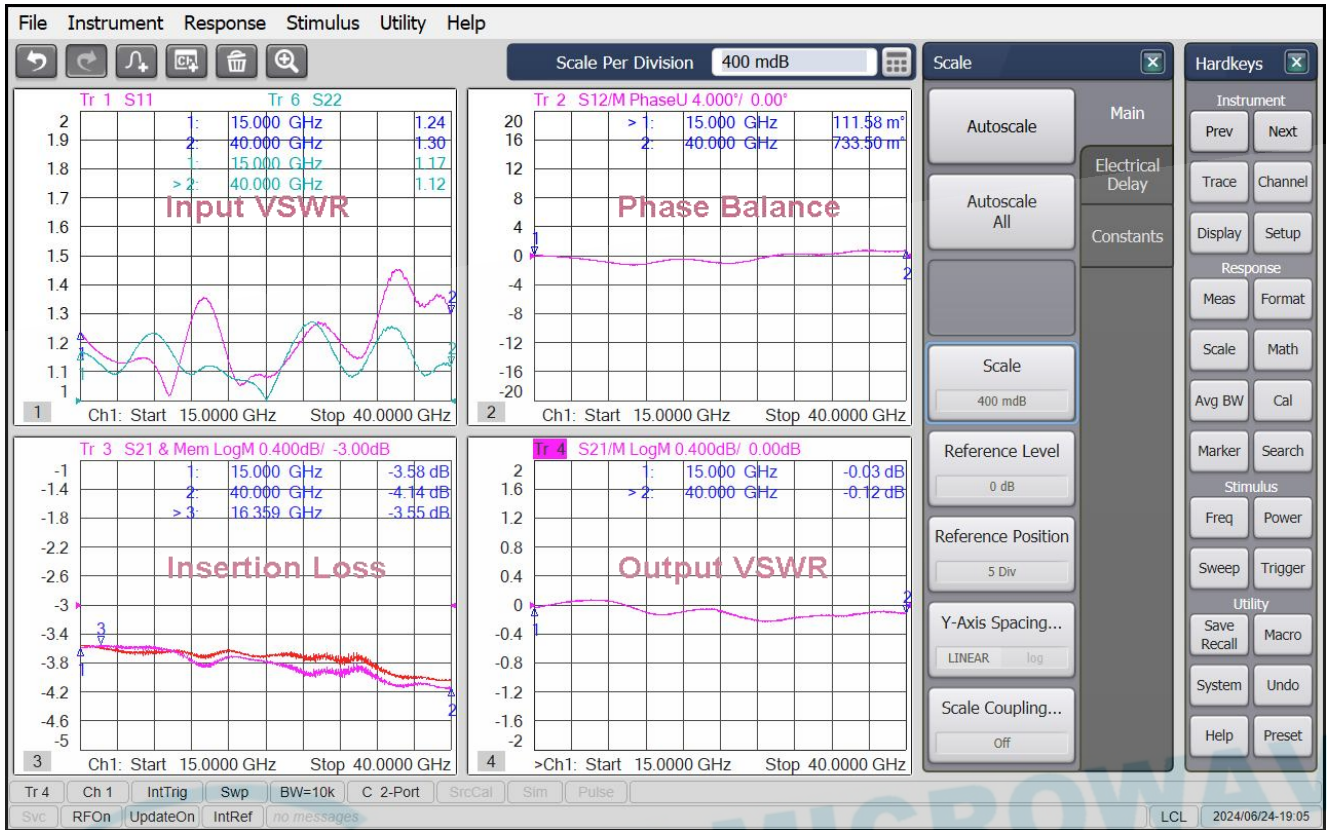

2. Isolation

