

Model TDC7090N10

Features

Low VSWR
High Directivity
Broadband & Miniature Size

Technical Data Sheet			
Frequency Range	7~9GHz	Finish	Painted Blue_ RAL #5007
Insertion Loss	≤0.6dB (Excl. Coupling Loss 0.46dB)	Connector Body	Passivated Stainless Steel
Coupling Factor	≤10±0.7dB	Housing	Aluminum, 6061 T6 Clear Chem Conversion Film
Coupling Sensitivity	≤±0.7dB	Connector Pin	Beryllium Copper, Gold Plate
Directivity	≥15dB	Solder	Lead Free, RoHS Compliant
VSWR	Primary ≤1.50:1 Secondary ≤1.50:1	Operating Temperature	-40~+85°C
¹ Power Handling	Incident ≤50Watt; Reflected ≤50Watt	Operating Humidity	Up to 95%, Non- Condensing
Impedance	50Ω	Weight	160g
Port Connectors	N-Female		

¹Power Handling guaranteed when load's VSWR within 1.50:1.

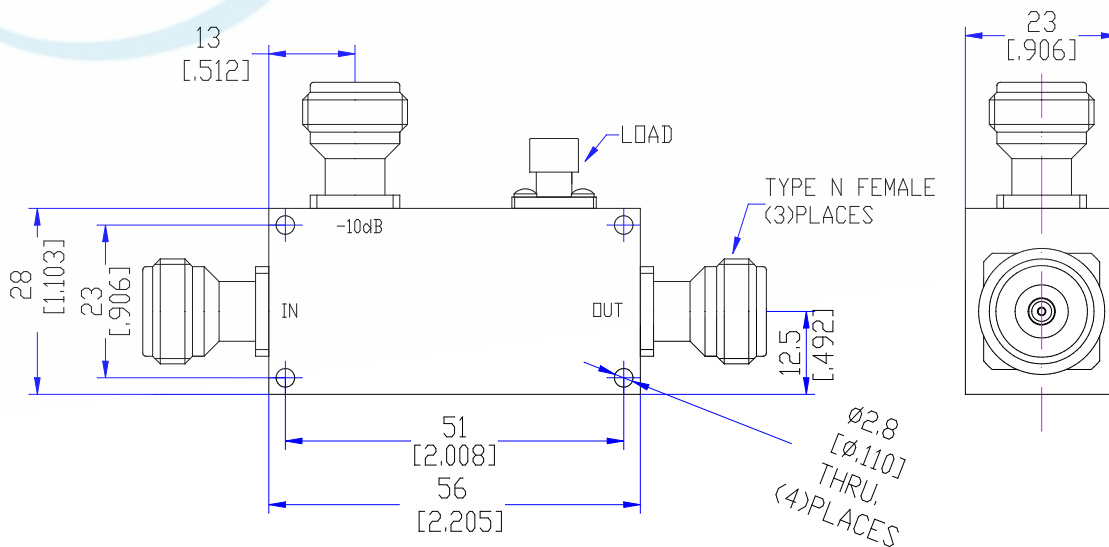

Typical Performance

1. Coupling Factor & Sensitivity, Isolation, VSWR

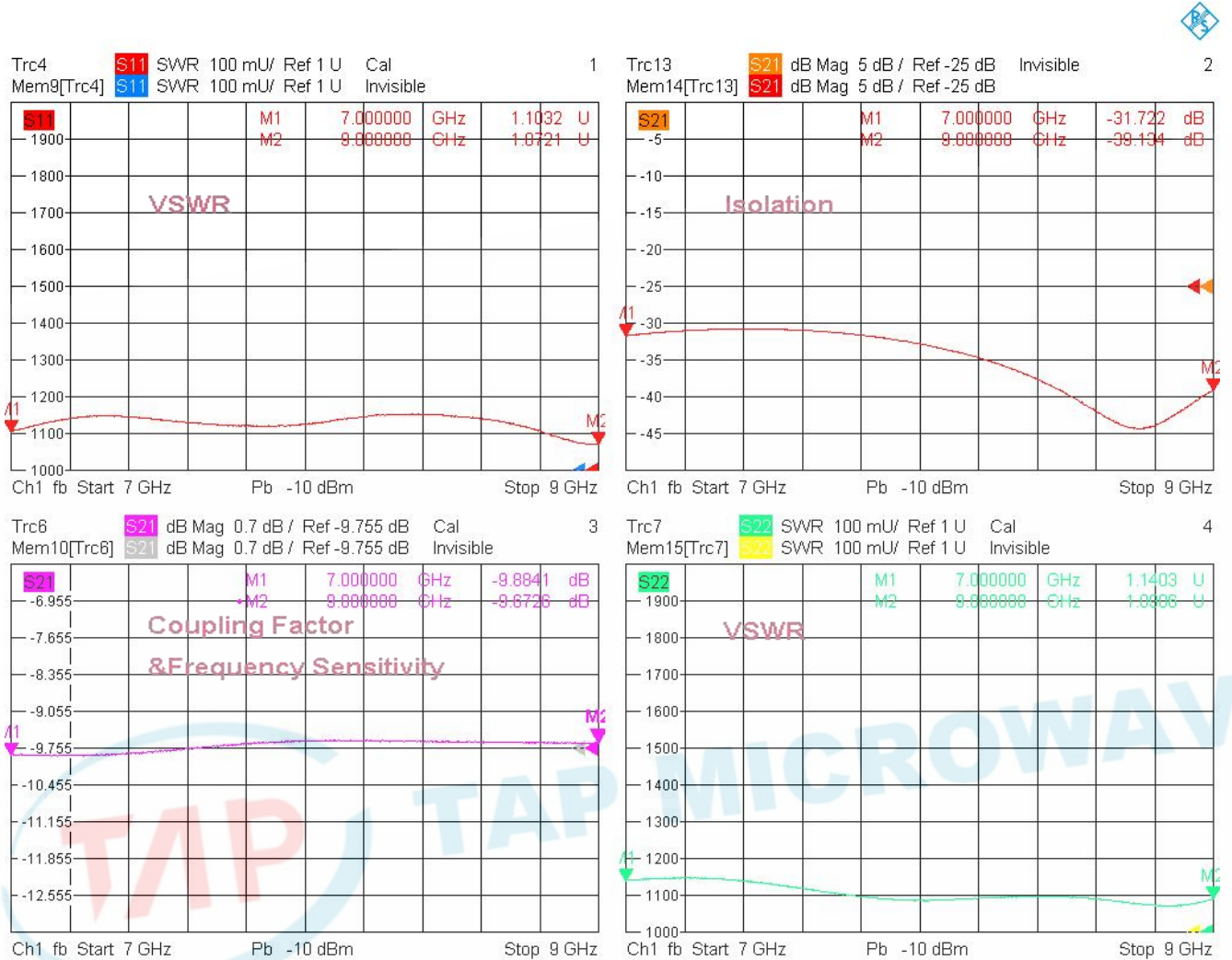

7/4/2023, 4:03 PM

2. Insertion Loss

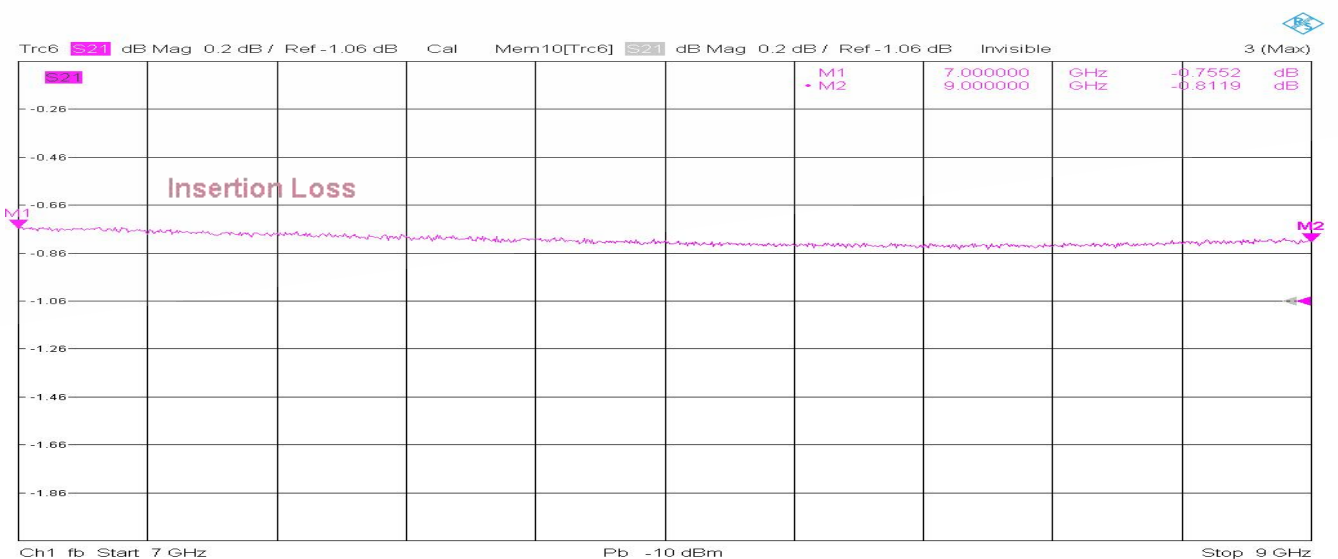

7/4/2023, 4:04 PM

